

# 12M7.0

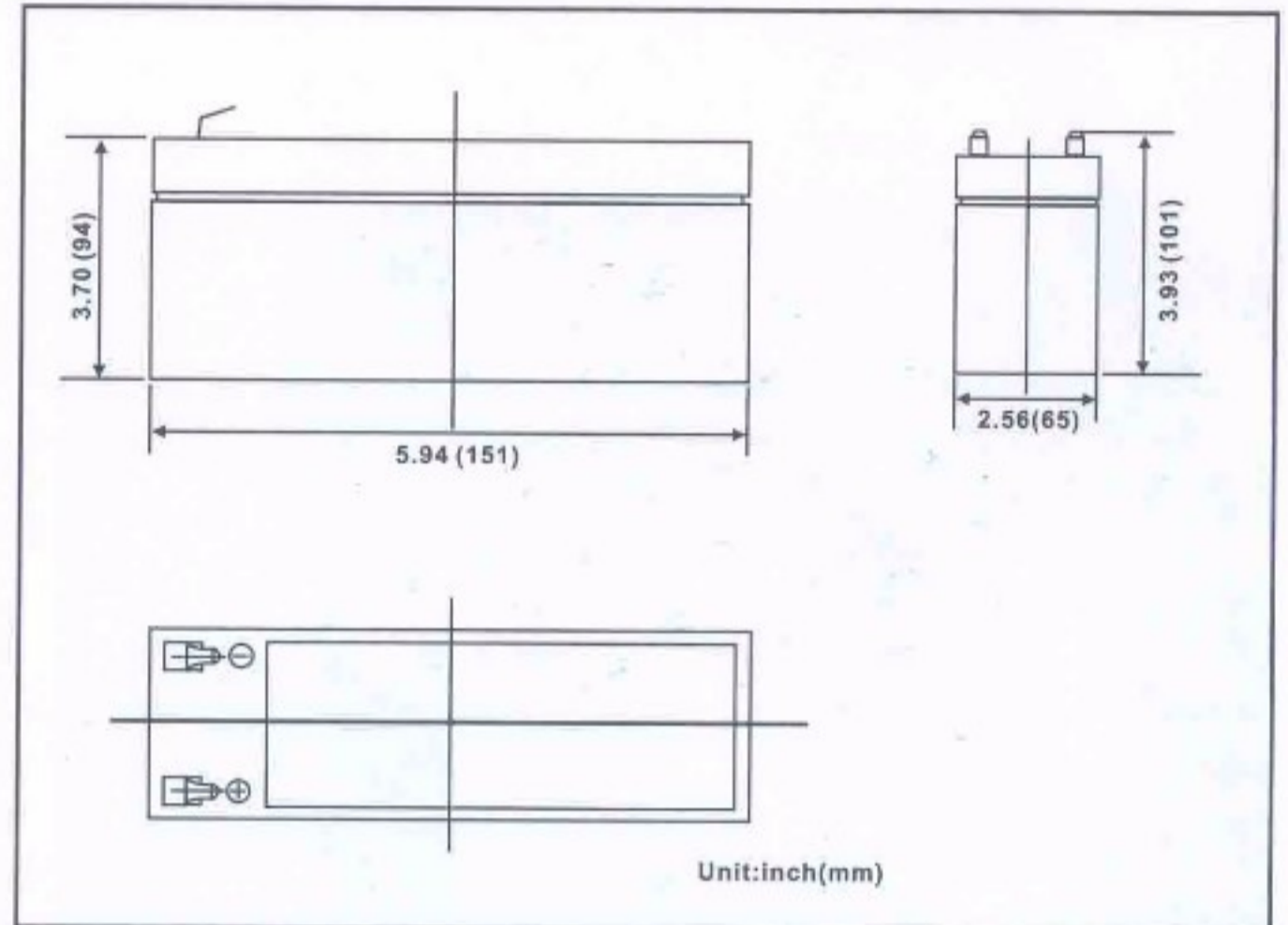

## SPECIFICATIONS

Nominal Voltage		12V			
Nominal Capacity		7.0Ah			
Dimensions	Length	5.94 inches(151mm)	Weight	Approx 5.29lbs (2400g)	
	Width	2.56 inches(65mm)			
Dimensions	Height	3.70 inches(94mm)	Terminals	F2(standard)	
	Total Height	3.93 inches(100mm)		F3(optional)	
Capacity 77°F(25°C)	20 hour rate(360mA)	7.2 Ah	Constant Voltage Charge	Cycle	Initial Charging Current less than 2.1A Voltage 14.5-14.9V at 77°F(25°C)Temp.coefficient -30mv/°C
	10 hour rate(668mA)	6.6 Ah			
	5 hour rate(1152mA)	5.7 Ah			
	1 hour rate(4760mA)	4.9 Ah			
	15 minute rate(13.6A)	3.4 Ah			
Capacity affected by Temperature	104°F(40°C)	102%	Standby	Initial Charging Current less than 2.1A Voltage 13.50-13.80V at 77°F(25°C)Temp.coefficient -20mv/°C	
	77°F(25°C)	100%			
	32°F(0°C)	85%			
	5°F(-15°C)	65%			
Internal Resistance	Full charged battery 77°F(25°C) < 25mΩ				

Discharge Characteristics @ 77°F(25°C)

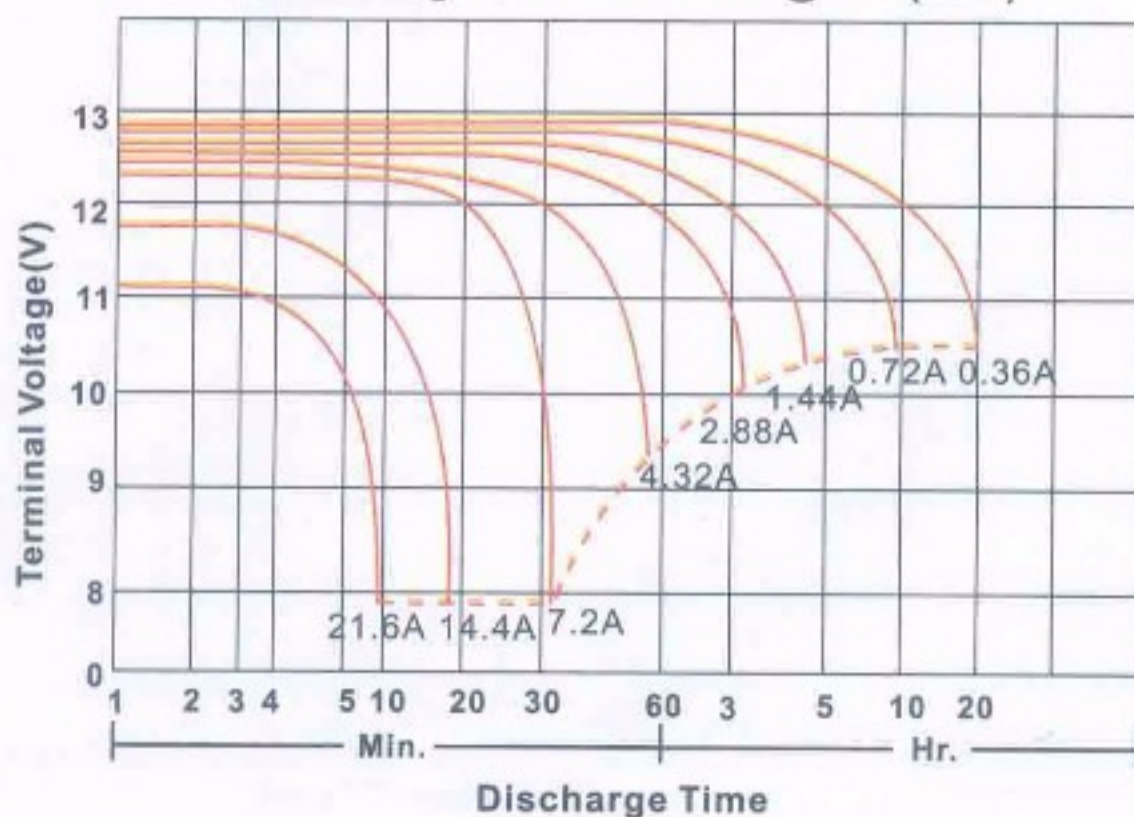

Discharge Time Vs. Discharge current

